

Plastic enclosure

TIBOX[®]
TIANQI ELECTRIC

Terminal block box

IP66 IK09



Plastic enclosure

TJ series plastic enclosure(metal screw type)

The enclosure is according to EN60529 standard, free from corrosion, compressive property and insulation, widely used in electronics, communications, fire fighting apparatus, control panel terminal boxes, for PCB, public accommodation, ship industry, food industry etc. we always give top priority to quality and safety, your satisfaction is guaranteed.

Temperature range: -40°C to +120°C ABS: Acrylonitrile Butadiene Styrene PC: Poly Carbonate

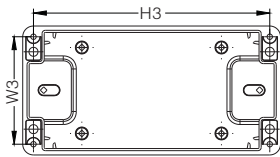

Body

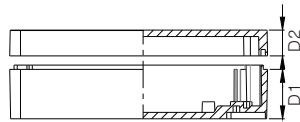

Cover + body

Metal screw type		Dimension(mm)		Mounting plate	Installation size(mm)	
Grey door	Clear door	W X H X D	D1+D2	Metal	W3	H3
TJ-NG-0505	TJ-NT-0505	50×52×40	28+12	TJ-0505	38	40
TJ-NG-0506-S	TJ-NT-0506-S	50×65×35	23+12	TJ-0506	40	55
TJ-NG-0608	TJ-NT-0608	60×85×33	21+12	TJ-0608	50	75
TJ-NG-0612	TJ-NT-0612	60×120×35	23+12	TJ-0612	50	110
TJ-NG-0606	TJ-NT-0606	65×65×57	45+12	TJ-0606	55	41
TJ-NG-0606-1	TJ-NT-0606-1	65×65×81	69+12	TJ-0606	55	41
TJ-NG-0606-S	TJ-NT-0606-S	65×65×35	23+12	TJ-0606	55	55
TJ-NG-0607	TJ-NT-0607	65×72×47	35+12	TJ-0607	55	62
TJ-NG-0610-S	TJ-NT-0610-S	68×100×35	20+15	TJ-0610	58	90
TJ-NG-0610	TJ-NT-0610	68×100×60	45+15	TJ-0610	58	90
TJ-NG-0610-1S	TJ-NT-0610-1S	68×100×40	20+20	TJ-0610	58	90
TJ-NG-0610-1	TJ-NT-0610-1	68×100×65	45+20	TJ-0610	58	90
TJ-NG-0713-S	TJ-NT-0713-S	70×130×35	23+12	TJ-0713	60	120
TJ-NG-0713	TJ-NT-0713	70×130×60	48+12	TJ-0713	60	120
TJ-NG-0713-1S	TJ-NT-0713-1S	70×130×43	23+20	TJ-0713	60	120
TJ-NG-0713-1	TJ-NT-0713-1	70×130×68	48+20	TJ-0713	60	120
★ TJ-NG-0610-Q	TJ-NT-0610-Q	68×100×50	35+15	TJ-0610	57	88
TJ-NG-1014	TJ-NT-1014	140×105×85	65+20	TJ-1014	92.5	127
TJ-NG-1014-1	TJ-NT-1014-1	140×105×105	85+20	TJ-1014	92.5	127
TJ-NG-1616	TJ-NT-1616	160×160×90	70+20	TJ-1616	147	147
TJ-NG-2330	TJ-NT-2330	230×300×90	60+30	TJ-2330	218.5	288
TJ-NG-2330-1	TJ-NT-2330-1	230×300×110	80+30	TJ-2330	218.5	288

Note: ★ TJ-NG-0610-Q with wall mount holes design



Foot hold
MODEL: NG-01



To fix PCB



To fix terminals



To fix inner metal plate



Wall mounting brackets
MODEL: NG-02



Wall mounting brackets



TJ-NG-0610-Q with wall mount holes design



Example: speed control switch

TJ series plastic enclosure(screw type)

The enclosure is according to EN60529 standard, free from corrosion, compressive property and insulation, widely used in electronics, communications, fire fighting apparatus, control panel terminal boxes, for PCB, public accommodation, ship industry, food industry etc. we always give top priority to quality and safety, your satisfaction is guaranteed. Temperature range: -40°C to +120°C

ABS: Acrylonitrile Butadiene Styrene PC: Poly Carbonate



Screw type		Dimension(mm)		Mounting plate	Installation size(mm)	
Grey door	Clear door	W X H X D	D1+D2	Metal	W3	H3
★ TJ-AG-0507	TJ-AT-0507	55×70×43	35+8	TJ-0507	47	52
★ TJ-AG-0509	TJ-AT-0509	55×91×43	35+8	TJ-0509	47	78
★ TJ-AG-0709	TJ-AT-0709	75×91×73	35+8	TJ-0709	67	78
★ TJ-AG-0910	TJ-AT-0910	91×110×43	35+8	TJ-0910	78	105
TJ-AG-1018	TJ-AT-1018	110×180×75	60+15	TJ-1018	76	155
TJ-AG-1022	TJ-AT-1022	100×223×75	60+15	TJ-1022	76	198

Note: ★ with metal screws

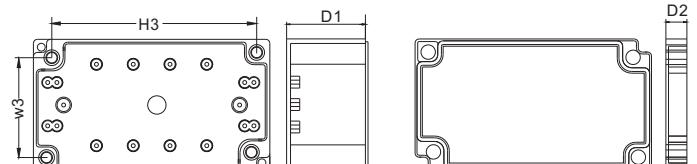

Plastic enclosure

TJ series plastic enclosure(screw type)

The enclosure is about 25% the weight of a metal box and can be easily installed or moved. The products are free from corrosion, carry superior insulation. The enclosure is available for the installation of terminal substitution rail, button box, small terminal, signal, relay, and sensor, communication and joint box. It will not be damaged even using for a long time because stainless hinges and draw latches are equipped. It secures perfect airtightness by preventing sink down when opening or closing the sizes of hinge and draw latch by size increasing of the products. It can be used in inferior or dangerous industrial field by using strong material and structure
 Temperature range: -40°C to +120°C ABS: Acrylonitrile Butadiene Styrene PC: Poly Carbonate

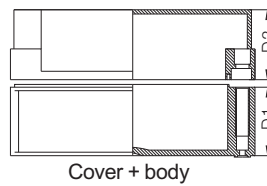
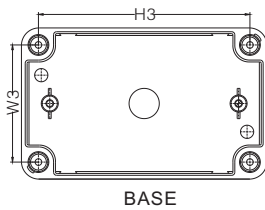

Steel mounting plate



Plastic mounting plate



Wall brackets for Plastic box
MODEL: WP-01



Plastic enclosure screw
MODEL: TJLT-70



Plastic enclosure screw
MODEL: TJM-60



Plastic enclosure screw
MODEL: TJS-50

Screw type		Dimension(mm)		Mounting plate		Installation size(mm)	
Grey door	Clear door	W X H X D	D1+D2	Plastic	Metal	W3	H3
★ TJ-AG-0506	TJ-AT-0506	50×65×55	40 + 15	/	TJ-0506	37	52
TJ-AG-0609	TJ-AT-0609	65×95×55	35 + 20	/	/	50	79
TJ-AG-0712	TJ-AT-0712	75×125×75	50 + 25	TJ-0712P	TJ-0712	56	107
TJ-AG-0712-1	TJ-AT-0712-1	75×125×100	50 + 50	TJ-0712P	TJ-0712	56	107
TJ-AG-0808	TJ-AT-0808	80×80×60	45 + 15	TJ-0808P	TJ-0808	62	62
TJ-AG-0808-1	TJ-AT-0808-1	80×80×85	70 + 15	TJ-0808P	TJ-0808	62	62
TJ-AG-0811-S	TJ-AT-0811-S	80×110×45	25 + 20	TJ-0811P	TJ-0811	62	92
TJ-AG-0811-1S	TJ-AT-0811-1S	80×110×60	35 + 25	TJ-0811P	TJ-0811	62	92
TJ-AG-0811	TJ-AT-0811	80×110×70	50 + 20	TJ-0811P	TJ-0811	62	92
TJ-AG-0811-1	TJ-AT-0811-1	80×110×85	50 + 35	TJ-0811P	TJ-0811	62	92
TJ-AG-0813	TJ-AT-0813	80×130×70	50 + 20	TJ-0813P	TJ-0813	62	112
TJ-AG-0813-1	TJ-AT-0813-1	80×130×85	50 + 35	TJ-0813P	TJ-0813	62	112
★ TJ-AG-0816-S	TJ-AT-0816-S	80×160×55	40 + 15	TJ-0816P	TJ-0816	68	146
★ TJ-AG-0816	TJ-AT-0816	80×160×90	75 + 15	TJ-0816P	TJ-0816	68	146
TJ-AG-0818	TJ-AT-0818	80×180×70	50 + 20	TJ-0818P	TJ-0818	62	162
TJ-AG-0818-1	TJ-AT-0818-1	80×180×85	50 + 35	TJ-0818P	TJ-0818	62	162
TJ-AG-0822	TJ-AT-0822	80×220×70	50 + 20	TJ-0822P	TJ-0822	62	202
TJ-AG-0825	TJ-AT-0825	80×250×70	50 + 20	TJ-0825P	TJ-0825	62	232
TJ-AG-0825-1	TJ-AT-0825-1	80×250×85	50 + 35	TJ-0825P	TJ-0825	62	232
TJ-AG-0825-2	TJ-AT-0825-2	80×250×100	50 + 50	TJ-0825P	TJ-0825	62	232
TJ-AG-1010	TJ-AT-1010	100×100×75	55 + 20	TJ-1010P	TJ-1010	82	82
TJ-AG-1010-1	TJ-AT-1010-1	100×100×100	80 + 20	TJ-1010P	TJ-1018	82	82
TJ-AG-1118	TJ-AT-1118	110×180×90	70 + 20	TJ-1118P	TJ-1118	95	165
TJ-AG-1118-1	TJ-AT-1118-1	110×180×105	70 + 35	TJ-1118P	TJ-1118	95	165
TJ-AG-1212-S	TJ-AT-1212-S	125×125×75	55 + 20	TJ-1212P	TJ-1212	105	105
TJ-AG-1212	TJ-AT-1212	125×125×100	80 + 20	TJ-1212P	TJ-1212	105	105
TJ-AG-1217	TJ-AT-1217	125×175×75	50 + 25	TJ-1217P	TJ-1217	105	156
TJ-AG-1217-1	TJ-AT-1217-1	125×175×100	50 + 50	TJ-1217P	TJ-1217	105	156
TJ-AG-1220	TJ-AT-1220	200×120×75	60 + 15	TJ-1220P	TJ-1220	102	182
TJ-AG-1222	TJ-AT-1222	220×120×85	67 + 20	TJ-1222P	TJ-1222	100	200
TJ-AG-1417	TJ-AT-1417	140×170×95	75 + 20	TJ-1417P	TJ-1417	122	152
TJ-AG-1423	TJ-AT-1423	140×230×90	70 + 20	TJ-1423P	TJ-1423	122	211
TJ-AG-1520-S	TJ-AT-1520-S	150×200×75	50 + 25	TJ-1520P	TJ-1520	132	182
TJ-AG-1520	TJ-AT-1520	150×200×100	80 + 20	TJ-1520P	TJ-1520	132	182
TJ-AG-1520-1	TJ-AT-1520-1	150×200×130	80 + 50	TJ-1520P	TJ-1520	132	182
TJ-AG-1520-2	TJ-AT-1520-2	150×200×130	110 + 20	TJ-1520P	TJ-1520	132	182
TJ-AG-1520-3	TJ-AT-1520-3	150×200×160	110 + 50	TJ-1520P	TJ-1520	132	182
TJ-AG-1525	TJ-AT-1525	150×250×100	80 + 20	TJ-1525P	TJ-1525	132	232
TJ-AG-1525-1	TJ-AT-1525-1	150×250×130	80 + 50	TJ-1525P	TJ-1525	132	232
TJ-AG-1525-2	TJ-AT-1525-2	150×250×130	110 + 20	TJ-1525P	TJ-1525	132	232
TJ-AG-1525-3	TJ-AT-1525-3	150×250×160	110 + 50	TJ-1525P	TJ-1525	132	232
TJ-AG-1717	TJ-AT-1717	175×175×75	50 + 25	TJ-1717P	TJ-1717	156	156
TJ-AG-1717-1	TJ-AT-1717-1	175×175×100	50 + 50	TJ-1717P	TJ-1717	156	156
TJ-AG-1725	TJ-AT-1725	175×250×75	50 + 25	TJ-1725P	TJ-1725	156	232
TJ-AG-1725-1	TJ-AT-1725-1	175×250×100	50 + 50	TJ-1725P	TJ-1725	155	232
★ TJ-AG-1825	TJ-AT-1825	180×250×100	85 + 15	/	TJ-1825	155	225
TJ-AG-2020-S	TJ-AT-2020-S	200×200×95	75 + 20	TJ-2020P	TJ-2020	182	182
TJ-AG-2020-1	TJ-AT-2020-1	200×200×125	75 + 50	TJ-2020P	TJ-2020	182	182
TJ-AG-2020	TJ-AT-2020	200×200×130	110 + 20	TJ-2020P	TJ-2020	182	182
TJ-AG-2020-2	TJ-AT-2020-2	200×200×160	110 + 50	TJ-2020P	TJ-2020	182	182
TJ-AG-2025	TJ-AT-2025	250×200×100	75 + 25	TJ-2025P	TJ-2025	178	223
TJ-AG-2030	TJ-AT-2030	300×200×105	85 + 20	TJ-2030P	TJ-2030	180	280

Note: ★ This size plastic boxes are with stainless steel screws



Plastic enclosure-stainless steel latch-screw type

TJ series plastic enclosure(with stainless steel hinge & latch type)

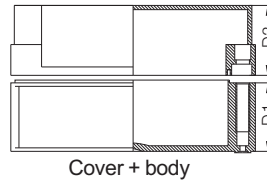
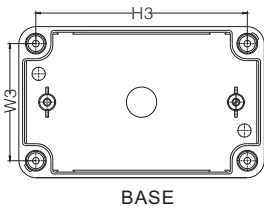

Steel mounting plate



Plastic mounting plate

Wall brackets for Plastic box
MODEL:WP-01



Cap for screw
MODEL:ZC-S10



Stainless steel hinge
MODEL:HG-01



Stainless steel latch
MODEL:LC-01

Hinges to be fixed on the longer side of enclosure.(If hinges on the shorter side needed is available as customized request)

Hinge+latch type		Dimension(mm)		Mounting plate		installation size(mm)	
Grey door	Clear door	W X H X D	D1+D2	Plastic	Metal	W3	H3
TJ-AG-0712H	TJ-AT-0712H	75×125×75	50 + 25	TJ-0712P	TJ-0712	56	107
TJ-AG-0712-1H	TJ-AT-0712-1H	75×125×100	50 + 50	TJ-0712P	TJ-0712	56	107
TJ-AG-0808-1H	TJ-AT-0808-1H	80×80×85	70 + 15	/	TJ-0808	62	62
TJ-AG-0811H	TJ-AT-0811H	80×110×70	50 + 20	TJ-0811P	TJ-0811	62	92
TJ-AG-0811-1H	TJ-AT-0811-1H	80×110×85	50 + 35	TJ-0811P	TJ-0811	62	92
TJ-AG-0813H	TJ-AT-0813H	80×130×70	50 + 20	TJ-0813P	TJ-0813	62	112
TJ-AG-0813-1H	TJ-AT-0813-1H	80×130×85	50 + 35	TJ-0813P	TJ-0813	62	112
TJ-AG-0816H	TJ-AT-0816H	80×160×90	75 + 15	TJ-0816P	TJ-0816	68	146
TJ-AG-0818H	TJ-AT-0818H	80×180×70	50 + 20	TJ-0818P	TJ-0818	62	162
TJ-AG-0818-1H	TJ-AT-0818-1H	80×180×85	50 + 35	TJ-0818P	TJ-0818	62	162
TJ-AG-0822H	TJ-AT-0822H	80×220×70	50 + 20	TJ-0822P	TJ-0822	62	202
TJ-AG-0825H	TJ-AT-0825H	80×250×70	50 + 20	TJ-0825P	TJ-0825	62	232
TJ-AG-0825-1H	TJ-AT-0825-1H	80×250×85	50 + 35	TJ-0825P	TJ-0825	62	232
TJ-AG-0825-2H	TJ-AT-0825-2H	80×250×100	50 + 50	TJ-0825P	TJ-0825	62	232
TJ-AG-1010H	TJ-AT-1010H	100×100×75	55 + 20	TJ-1010P	TJ-1010	82	82
TJ-AG-1010-1H	TJ-AT-1010-1H	100×100×100	80 + 20	TJ-1010P	TJ-1010	82	82
TJ-AG-1118H	TJ-AT-1118H	110×180×90	70 + 20	TJ-1118P	TJ-1118	95	165
TJ-AG-1118-1H	TJ-AT-1118-1H	110×180×105	70 + 35	TJ-1118P	TJ-1118	95	165
TJ-AG-1212-SH	TJ-AT-1212-SH	125×125×75	55 + 20	TJ-1212P	TJ-1212	105	105
TJ-AG-1212H	TJ-AT-1212H	125×125×100	80 + 20	TJ-1212P	TJ-1212	105	105
TJ-AG-1217H	TJ-AT-1217H	125×175×75	50 + 25	TJ-1217P	TJ-1217	105	156
TJ-AG-1217-1H	TJ-AT-1217-1H	125×175×100	50 + 50	TJ-1217P	TJ-1217	105	156
TJ-AG-1220H	TJ-AT-1220H	200×120×75	60 + 15	TJ-1220P	TJ-1220	102	182
TJ-AG-1222H	TJ-AT-1222H	220×120×85	67 + 20	TJ-1222P	TJ-1222	100	200
TJ-AG-1417H	TJ-AT-1417H	140×170×95	75 + 20	TJ-1417P	TJ-1417	122	152
TJ-AG-1423H	TJ-AT-1423H	140×230×90	70 + 20	TJ-1423P	TJ-1423	122	211
TJ-AG-1520-SH	TJ-AT-1520-SH	150×200×75	50 + 25	TJ-1520P	TJ-1520	132	182
TJ-AG-1520H	TJ-AT-1520H	150×200×100	80 + 20	TJ-1520P	TJ-1520	132	182
TJ-AG-1520-1H	TJ-AT-1520-1H	150×200×130	80 + 50	TJ-1520P	TJ-1520	132	182
TJ-AG-1520-2H	TJ-AT-1520-2H	150×200×130	110 + 20	TJ-1520P	TJ-1520	132	182
TJ-AG-1520-3H	TJ-AT-1520-3H	150×200×160	110 + 50	TJ-1520P	TJ-1520	132	182
TJ-AG-1525H	TJ-AT-1525H	150×250×100	80 + 20	TJ-1525P	TJ-1525	132	232
TJ-AG-1525-1H	TJ-AT-1525-1H	150×250×130	80 + 50	TJ-1525P	TJ-1525	132	232
TJ-AG-1525-2H	TJ-AT-1525-2H	150×250×130	110 + 20	TJ-1525P	TJ-1525	132	232
TJ-AG-1525-3H	TJ-AT-1525-3H	150×250×160	110 + 50	TJ-1525P	TJ-1525	132	232
TJ-AG-1717H	TJ-AT-1717H	175×175×75	50 + 25	TJ-1717P	TJ-1717	156	156
TJ-AG-1717-1H	TJ-AT-1717-1H	175×175×100	50 + 50	TJ-1717P	TJ-1717	156	156
TJ-AG-1725H	TJ-AT-1725H	175×250×75	50 + 25	TJ-1725P	TJ-1725	156	232
TJ-AG-1725-1H	TJ-AT-1725-1H	175×250×100	50 + 50	TJ-1725P	TJ-1725	155	232
TJ-AG-1825H	TJ-AT-1825H	180×250×95	75 + 20	TJ-2020P	TJ-1825	155	225
TJ-AG-2020-SH	TJ-AT-2020-SH	200×200×100	85 + 15	/	TJ-2020	182	182
TJ-AG-2020-1H	TJ-AT-2020-1H	200×200×125	75 + 50	TJ-2020P	TJ-2020	182	182
TJ-AG-2020H	TJ-AT-2020H	200×200×130	110 + 20	TJ-2020P	TJ-2020	182	182
TJ-AG-2020-2H	TJ-AT-2020-2H	200×200×160	110 + 50	TJ-2020P	TJ-2020	182	182
TJ-AG-2025H	TJ-AT-2025H	250×200×100	75 + 25	TJ-2025P	TJ-2025	178	223
TJ-AG-2030H	TJ-AT-2030H	300×200×105	85 + 25	TJ-2030P	TJ-2030	180	280

Note: ★ This size plastic boxes are with stainless steel screws

Switch box -push button box



Product model	W X H X D(mm)
TJ-AG 0808-Q1	80×80×60
TJ-AG 0813-Q2	80×130×70
TJ-AG 0818-Q3	80×180×70
TJ-AG 0825-Q4	80×250×70

Product model	W X H X D(mm)
TJ-AG 0808-K1	80×80×60
TJ-AG 0813-K2	80×130×70
TJ-AG 0818-K3	80×180×70
TJ-AG 0825-K4	80×250×70

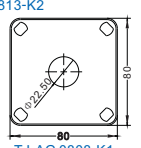
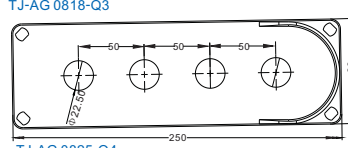
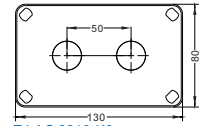
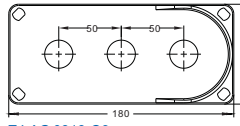
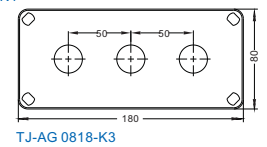
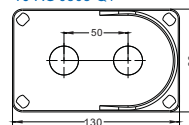
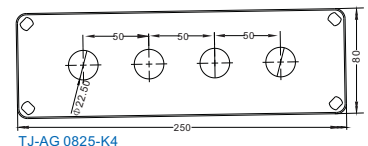
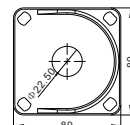

Plastic enclosure

TJ series plastic enclosure – big switch box(screw type)

The enclosure is according to EN60529 standard, free from corrosion, compressive property and insulation, widely used in electronics, communications, fire fighting apparatus, control panel terminal boxes, public accommodation, ship industry, food industry etc. we always give top priority to quality and safety, your satisfaction is guaranteed.

Temperature range: -40°C to +120°C ABS: Acrylonitrile Butadiene Styrene PC: Poly Carbonate



Fixed by inner plate



Fixing accessories for inner plate

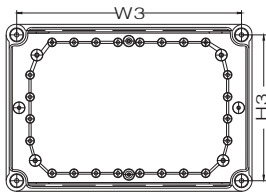

Body

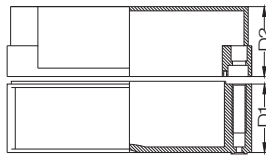

Cover + body



Steel mounting plate



Plastic mounting plate

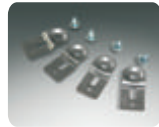

Wall brackets for Plastic box
MOEDL:WP-02



Inner door hinge fixing
MOEDL:LC-S11



Fixing bolts for inner plate
MOEDL:LC-S12



Plastic enclosure screw
MOEDL:TJCB-70



Plastic enclosure screw
MOEDL:TJCB-50

Screw type		Dimension(mm)		Mounting plate		Installation size(mm)	
Grey door	Clear door	W X H X D	D1+D2	Plastic	Metal	W3	H3
TJ-AG-2819	TJ-AT-2819	280×190×130	100+30	TJ-2819P	TJ-2819	255	165
TJ-AG-2819-1	TJ-AT-2819-1	280×190×180	100+80	TJ-2819P	TJ-2819	255	165
TJ-AG-2819-2	TJ-AT-2819-2	280×190×180	150+30	TJ-2819P	TJ-2819	255	165
TJ-AG-2819-3	TJ-AT-2819-3	280×190×230	150+80	TJ-2819P	TJ-2819	255	165
TJ-AG-2828	TJ-AT-2828	280×280×130	100+30	TJ-2828P	TJ-2828	255	255
TJ-AG-2828-1	TJ-AT-2828-1	280×280×180	100+80	TJ-2828P	TJ-2828	255	255
TJ-AG-2828-2	TJ-AT-2828-2	280×280×180	150+30	TJ-2828P	TJ-2828	255	255
TJ-AG-2828-3	TJ-AT-2828-3	280×280×230	150+80	TJ-2828P	TJ-2828	255	255
TJ-AG-3428	TJ-AT-3428	340×280×130	100+30	TJ-3428P	TJ-3428	315	255
TJ-AG-3428-1	TJ-AT-3428-1	340×280×180	100+80	TJ-3428P	TJ-3428	355	355
TJ-AG-3819-S	TJ-AT-3819-S	380×190×100	70+30	TJ-3819P	TJ-3819	355	165
TJ-AG-3819	TJ-AT-3819	380×190×130	100+30	TJ-3819P	TJ-3819	355	165
TJ-AG-3819-1	TJ-AT-3819-1	380×190×180	150+30	TJ-3819P	TJ-3819	355	165
TJ-AG-3828	TJ-AT-3828	380×280×130	100+30	TJ-3828P	TJ-3828	355	255
TJ-AG-3828-1	TJ-AT-3828-1	380×280×180	100+80	TJ-3828P	TJ-3828	355	255
TJ-AG-3828-2	TJ-AT-3828-2	380×280×180	150+30	TJ-3828P	TJ-3828	355	255
TJ-AG-3828-3	TJ-AT-3828-3	380×280×230	150+80	TJ-3828P	TJ-3828	355	255
TJ-AG-2856	TJ-AT-2856	280×560×130	100+30	TJ-2828P*2	TJ-2856	540	255
TJ-AG-3856	TJ-AT-3856	380×560×180	150+30	TJ-3828P*2	TJ-3856	534	354

TJ series plastic enclosure-big switch box(with stainless steel hinge & latch type)

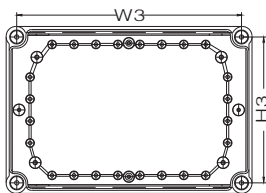

Body

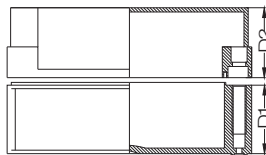

Cover + body



Steel mounting plate

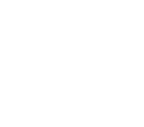

Plastic mounting plate



Wall brackets for Plastic box
MOEDL:WP-02



Door hinge fixing piece
MOEDL:LC-S11

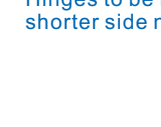

Fixing bolts
MOEDL:LC-S12

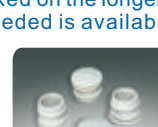

Cap for screw
MOEDL:ZC-S10

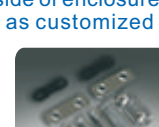

Stainless steel hinge
MOEDL:HG-02

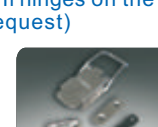

Stainless steel latch
MOEDL:LC-02

Hinge+latch type		Dimension(mm)		Mounting plate		Installation size(mm)	
Grey door	Clear door	W X H X D	D1+D2	Plastic	Metal	W3	H3
TJ-AG-2819H	TJ-AT-2819H	280×190×130	100+30	TJ-2819P	TJ-2819	255	165
TJ-AG-2819-1H	TJ-AT-2819-1H	280×190×180	100+80	TJ-2819P	TJ-2819	255	165
TJ-AG-2819-2H	TJ-AT-2819-2H	280×190×180	150+30	TJ-2819P	TJ-2819	255	165
TJ-AG-2819-3H	TJ-AT-2819-3H	280×190×230	150+80	TJ-2819P	TJ-2819	255	165
TJ-AG-2828H	TJ-AT-2828H	280×280×130	100+30	TJ-2828P	TJ-2828	255	255
TJ-AG-2828-1H	TJ-AT-2828-1H	280×280×180	100+80	TJ-2828P	TJ-2828	255	255
TJ-AG-2828-2H	TJ-AT-2828-2H	280×280×180	150+30	TJ-2828P	TJ-2828	255	255
TJ-AG-2828-3H	TJ-AT-2828-3H	280×280×230	150+80	TJ-2828P	TJ-2828	255	255
TJ-AG-3428H	TJ-AT-3428H	340×280×130	100+30	TJ-3428P	TJ-3428	315	255
TJ-AG-3428-1H	TJ-AT-3428-1H	340×280×180	100+80	TJ-3428P	TJ-3428	355	355
TJ-AG-3819H	TJ-AT-3819H	380×190×100	70+30	TJ-3819P	TJ-3819	355	165
TJ-AG-3819-1H	TJ-AT-3819-1H	380×190×180	150+30	TJ-3819P	TJ-3819	355	165
TJ-AG-3828H	TJ-AT-3828H	380×280×130	100+30	TJ-3828P	TJ-3828	355	255
TJ-AG-3828-1H	TJ-AT-3828-1H	380×280×180	100+80	TJ-3828P	TJ-3828	355	255
TJ-AG-3828-2H	TJ-AT-3828-2H	380×280×180	150+30	TJ-3828P	TJ-3828	355	255
TJ-AG-3828-3H	TJ-AT-3828-3H	380×280×230	150+80	TJ-3828P	TJ-3828	355	255
TJ-AG-2856H	TJ-AT-2856H	280×560×130	100+30	TJ-2828P*2	TJ-2856	540	255
TJ-AG-3856H	TJ-AT-3856H	380×560×180	150+30	TJ-3828P*2	TJ-3856	534	354

Hinges to be fixed on the longer side of enclosure. (If hinges on the shorter side needed is available as customized request)



K series combined plastic enclosure system

K series combined plastic enclosure system

K series combined plastic enclosure is a modular, multi-purpose low voltage distribution boards. Used in metallurgy, petroleum, chemical, industrial and mining enterprises and infrastructure for all occasions that require high reliability low pressure systems, power distribution and motor control systems. **K series combined plastic enclosure** is according to customer needs or different occasions, the cabinet can be mounted a variety of models and specifications of components. According to different electrical equipments. Various types of feed units can be mounted in a series of cabinet or a cabinet. Such as feeder circuits and motor control circuits can be mixed together. **K series combined plastic enclosure** is a full range of low voltage switch gear, meet your full range of needs. Used for 1200 A low pressure system. **K series combined plastic enclosure** can provide a high level of reliability and security. User friendly design, enhanced safety for personnel and equipment needed for protection.

2819-K1	2819-K2	2819-K3	2819-K4	2819-K5	2819-K6	2819-K7
TJ-AT-2819-K1 280×190×130 TJ-AT-2819-1-K1 280×190×180 TJ-AT-2819-2-K1 280×190×180	TJ-AT-2819-K2 280×190×130 TJ-AT-2819-1-K2 280×190×180 TJ-AT-2819-2-K2 280×190×180	TJ-AT-2819-K3 280×190×130 TJ-AT-2819-1-K3 280×190×180 TJ-AT-2819-2-K3 280×190×180	TJ-AT-2819-K4 280×190×130 TJ-AT-2819-1-K4 280×190×180 TJ-AT-2819-2-K4 280×190×180	TJ-AT-2819-K5 280×190×130 TJ-AT-2819-1-K5 280×190×180 TJ-AT-2819-2-K5 280×190×180	TJ-AT-2819-K6 280×190×130 TJ-AT-2819-1-K6 280×190×180 TJ-AT-2819-2-K6 280×190×180	TJ-AT-2819-K7 280×190×130 TJ-AT-2819-1-K7 280×190×180 TJ-AT-2819-2-K7 280×190×180
TJ-AT-2828-K1 280×280×130 TJ-AT-2828-1-K1 280×280×180 TJ-AT-2828-2-K1 280×280×180	TJ-AT-2828-K2 280×280×130 TJ-AT-2828-1-K2 280×280×180 TJ-AT-2828-2-K2 280×280×180	TJ-AT-2828-K3 280×280×130 TJ-AT-2828-1-K3 280×280×180 TJ-AT-2828-2-K3 280×280×180	TJ-AT-2828-K4 280×280×130 TJ-AT-2828-1-K4 280×280×180 TJ-AT-2828-2-K4 280×280×180	TJ-AT-2828-K5 280×280×130 TJ-AT-2828-1-K5 280×280×180 TJ-AT-2828-2-K5 280×280×180	TJ-AT-2828-K6 280×280×130 TJ-AT-2828-1-K6 280×280×180 TJ-AT-2828-2-K6 280×280×180	TJ-AT-2828-K7 280×280×130 TJ-AT-2828-1-K7 280×280×180 TJ-AT-2828-2-K7 280×280×180
TJ-AT-3819-K1 380×190×130 TJ-AT-3819-1-K1 380×190×180	TJ-AT-3819-K2 380×190×130 TJ-AT-3819-1-K2 380×190×180	TJ-AT-3819-K3 380×190×130 TJ-AT-3819-1-K3 380×190×180	TJ-AT-3819-K4 380×190×130 TJ-AT-3819-1-K4 380×190×180	TJ-AT-3819-K5 380×190×130 TJ-AT-3819-1-K5 380×190×180	TJ-AT-3819-K6 380×190×130 TJ-AT-3819-1-K6 380×190×180	TJ-AT-3819-K7 380×190×130 TJ-AT-3819-1-K7 380×190×180
TJ-AT-3828-K1 380×280×130 TJ-AT-3828-1-K1 380×280×180 TJ-AT-3828-2-K1 380×280×180	TJ-AT-3828-K2 380×280×130 TJ-AT-3828-1-K2 380×280×180 TJ-AT-3828-2-K2 380×280×180	TJ-AT-3828-K3 380×280×130 TJ-AT-3828-1-K3 380×280×180 TJ-AT-3828-2-K3 380×280×180	TJ-AT-3828-K4 380×280×130 TJ-AT-3828-1-K4 380×280×180 TJ-AT-3828-2-K4 380×280×180	TJ-AT-3828-K5 380×280×130 TJ-AT-3828-1-K5 380×280×180 TJ-AT-3828-2-K5 380×280×180	TJ-AT-3828-K6 380×280×130 TJ-AT-3828-1-K6 380×280×180 TJ-AT-3828-2-K6 380×280×180	TJ-AT-3828-K7 380×280×130 TJ-AT-3828-1-K7 380×280×180 TJ-AT-3828-2-K7 380×280×180
2856-K1	2856-K2	2856-K3	2856-K4	2856-K5	2856-K6	2856-K7
TJ-AT-2856-K1 280×560×130 TJ-AT-3856-K1 380×560×180	TJ-AT-2856-K2 280×560×130	TJ-AT-2856-K3 280×560×130	TJ-AT-2856-K4 280×560×130	TJ-AT-2856-K5 280×560×130	TJ-AT-2856-K6 280×560×130	TJ-AT-2856-K7 280×560×130
	TJ-AT-3856-K2 380×560×180	TJ-AT-3856-K3 380×560×180	TJ-AT-3856-K4 380×560×180	TJ-AT-3856-K5 380×560×180	TJ-AT-3856-K6 380×560×180	TJ-AT-3856-K7 380×560×180

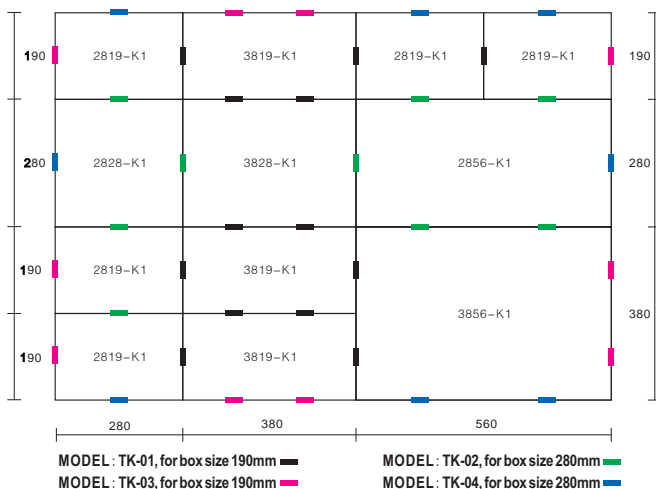

Joint plastic board
MODEL: TK-01, for box size 190mm

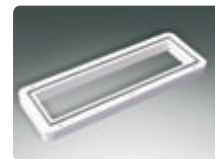

Joint plastic board
MODEL: TK-02, for box size 280mm

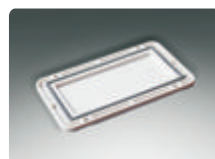

Plastic cable gland board
MODEL: TK-03, for box size 190mm



Joint plastic board
MODEL: TK-04, for box size 280mm



Plastic enclosure

Portable industrial socket plastic box(black screw type)

Portable, and provide flexible power supply output. Executive standard: DIN VDE0623 IEC60309-2
 Protection degree: IEC60529 IP44 IP67 Temperature range: -40°C to +120°C
 ABS: Acrylonitrile Butadiene Styrene PC: Poly Carbonate

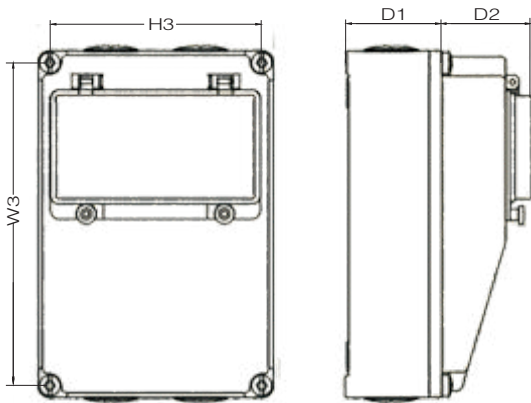
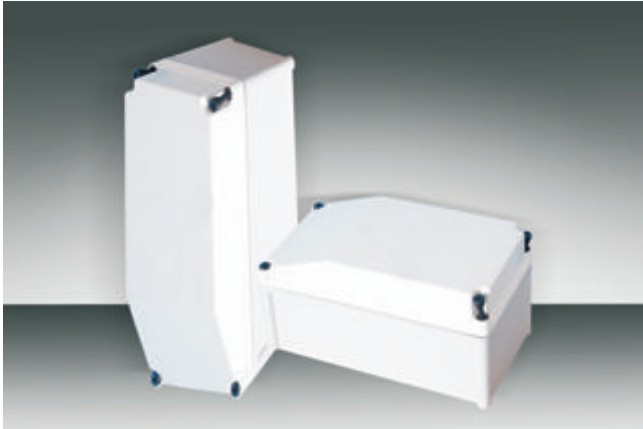

Screw type		Dimension(mm)		Mounting plate		installation size(mm)	
Grey door	Clear door	W X H X D	D1+D2	Plastic	Metal	W3	H3
TJ-AG-2819X	TJ-AT-2819X	280×190×150	100+50	TJ-2819P	TJ-2819	255	165
TJ-AG-2819-1X	TJ-AT-2819-1X	280×190×200	150+50	TJ-2819P	TJ-2819	255	165
TJ-AG-3819X	TJ-AT-3819X	380×190×150	100+50	TJ-3819P	TJ-3819	355	165
TJ-AG-3819-1X	TJ-AT-3819-1X	380×190×200	150+50	TJ-3819P	TJ-3819	355	165



black screw



black screw, open at 180 degree



back view



Portable industrial socket plastic box

TJ series plastic enclosure(corner hinge +screw type)



corner hinge, open at 180 degree



corner hinge, open at 180 degree

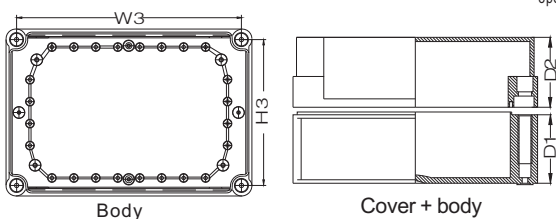

Hinge+Screw type		Dimension(mm)		Mounting plate		installation size(mm)	
Grey door	Clear door	W X H X D	D1+D2	Plastic	Metal	W3	H3
TJ-AG-2819L	TJ-AT-2819L	280×190×130	100+30	TJ-2819P	TJ-2819	255	165
TJ-AG-2819-1L	TJ-AT-2819-1L	280×190×180	100+80	TJ-2819P	TJ-2819	255	165
TJ-AG-2819-2L	TJ-AT-2819-2L	280×190×180	150+30	TJ-2819P	TJ-2819	255	165
TJ-AG-2819-3L	TJ-AT-2819-3L	280×190×230	150+80	TJ-2819P	TJ-2819	255	165
TJ-AG-2828L	TJ-AT-2828L	280×280×130	100+30	TJ-2828P	TJ-2828	255	255
TJ-AG-2828-1L	TJ-AT-2828-1L	280×280×180	100+80	TJ-2828P	TJ-2828	255	255
TJ-AG-2828-2L	TJ-AT-2828-2L	280×280×180	150+30	TJ-2828P	TJ-2828	255	255
TJ-AG-2828-3L	TJ-AT-2828-3L	280×280×230	150+80	TJ-2828P	TJ-2828	255	255
TJ-AG-3428L	TJ-AT-3428L	340×280×130	100+30	TJ-3428P	TJ-3428	315	255
TJ-AG-3428-1L	TJ-AT-3428-1L	340×280×180	100+80	TJ-3428P	TJ-3428	355	355
TJ-AG-3819-SL	TJ-AT-3819-SL	380×190×100	70+30	TJ-3819P	TJ-3819	355	165
TJ-AG-3819L	TJ-AT-3819L	380×190×130	100+30	TJ-3819P	TJ-3819	355	165
TJ-AG-3819-1L	TJ-AT-3819-1L	380×190×180	150+30	TJ-3819P	TJ-3819	355	165
TJ-AG-3828L	TJ-AT-3828L	380×280×130	100+30	TJ-3828P	TJ-3828	355	255
TJ-AG-3828-1L	TJ-AT-3828-1L	380×280×180	100+80	TJ-3828P	TJ-3828	355	255
TJ-AG-3828-2L	TJ-AT-3828-2L	380×280×180	150+30	TJ-3828-P	TJ-3828	355	255
TJ-AG-3828-3L	TJ-AT-3828-3L	380×280×230	150+80	TJ-3828P	TJ-3828	355	255
TJ-AG-2856L	TJ-AT-2856L	280×560×130	100+30	TJ-2828P×2	TJ-2856	540	255
TJ-AG-3856L	TJ-AT-3856L	380×560×180	150+30	TJ-3828P×2	TJ-3856	534	354



Plastic enclosure

MG,KG,TG series plastic enclosure

With high strength ABS, PC refractories and UV added material, the enclosure has beautiful appearance, high plasticity and ruggedness. It is Suitable for terminal boxes, distribution panels, instrument boxes, electrical equipment boxes and control boxes, simple and easy to use. Temperature range:-40 to +120℃ ABS:Acrylonitrile Butadiene Styrene PC:Poly Carbonate

MG series plastic enclosure(plastic latch+hinge type)



plastic latch+hinge type		Dimension(mm)		Mounting plate		installation size(mm)	
Grey door	Clear door	W X H X D	D1+D2	Plastic	Metal	W3	H3
TJ-MG-2030	TJ-MT-2030	200×300×180	130+50	TJ-2030P	TJ-2030	270	170
TJ-MG-3030	TJ-MT-3030	300×300×180	130+50	TJ-3030P	TJ-3030	270	270
TJ-MG-3040	TJ-MT-3040	300×400×180	130+50	TJ-3040P	TJ-3040	370	270
TJ-MG-3040-1	TJ-MT-3040-1	300×400×210	160+50	TJ-3040P	TJ-3040	370	270
TJ-MG-4050	TJ-MT-4050	400×500×200	150+50	TJ-4050P	TJ-4050	470	270
TJ-MG-4060	TJ-MT-4060	400×600×220	170+50	TJ-2030PX2	TJ-4060	570	370

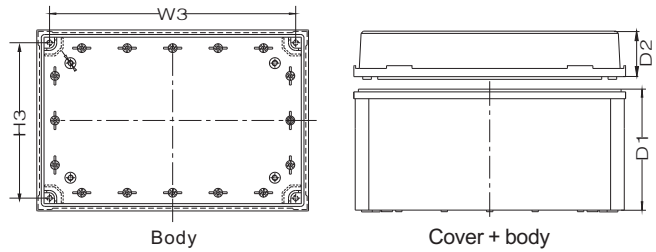

KG series plastic enclosure(lock type)



lock type		Dimension(mm)		Mounting plate		installation size(mm)	
Grey door	Clear door	W X H X D	D1+D2	Plastic	Metal	W3	H3
TJ-KG-2030	TJ-KT-2030	200×300×180	130+50	TJ-2030P	TJ-2030	270	170
TJ-KG-3030	TJ-KT-3030	300×300×180	130+50	TJ-3030P	TJ-3030	270	270
TJ-KG-3040	TJ-KT-3040	300×400×180	130+50	TJ-3040P	TJ-3040	370	270
TJ-KG-3040-1	TJ-KT-3040-1	300×400×210	160+50	TJ-3040P	TJ-3040	370	270
TJ-KG-4050	TJ-KT-4050	400×500×200	150+50	TJ-4050P	TJ-4050	470	270
TJ-KG-4060	TJ-KT-4060	400×600×220	170+50	TJ-2030PX2	TJ-4060	570	370



Fixing bolts for inner door
MOEDL:WG-01



hinges for fixing inner door
MOEDL:WG-02



Fixed with inner plate



Fixed with inner plate

TG series plastic enclosure(metal latch+hinge type)



metal latch+hinge type		Dimension(mm)		Mounting plate		installation size(mm)	
Grey door	Clear door	W X H X D	D1+D2	Plastic	Metal	W3	H3
TJ-MG-2227T	TJ-MT-2227T	225×275×120	100+20	/	TJ-2227	238	188
TJ-MG-2030-ST	TJ-MT-2030-ST	200×300×150	120+30	TJ-2030P	TJ-2030	268	168
TJ-MG-2030T	TJ-MT-2030T	200×300×180	130+50	TJ-2030P	TJ-2030	270	170
TJ-MG-3030T	TJ-MT-3030T	300×300×180	130+50	TJ-3030P	TJ-3030	270	270
TJ-MG-3040T	TJ-MT-3040T	300×400×180	130+50	TJ-3040P	TJ-3040	370	270
TJ-MG-3040T-1	TJ-MT-3040T-1	300×400×210	160+50	TJ-3040P	TJ-3040	370	270
TJ-MG-4050T	TJ-MT-4050T	400×500×200	150+50	TJ-4050P	TJ-4050	470	270
TJ-MG-4060T	TJ-MT-4060T	400×600×220	170+50	TJ-2030PX2	TJ-4060	570	370



Hoop(telegraph pole fixing)
MOEDL:BG 080



Fixed on the telegraph pole



Fixed on the telegraph pole



Wall brackets for big plastic box
MOEDL:MG



Stainless steel hinge
MOEDL:HG-02



Stainless steel latch
MOEDL:LC-02



plastic hinges for box MG,KG
MOEDL:PH-01



plastic latch for box MG
MOEDL:PL-01

Steel mounting plate

Plastic mounting plate

Plastic enclosure

TE series plastic enclosure(plastic latch+hinge type)

Out of the plastic boxes which are selling at present, it's ability and working efficiency, the competitive power is much higher with the low price same as the level of steel box. The products were added the electromagnetic interference(EMI) and prevent substance of the static electricity, and the strong point was given to the relevant mechanical protection of electricity, electron and etc.

Temperature range:-40℃ to +120℃ ABS:Acrulonitrile Butadiene Styrene PC:Poly Carbonate

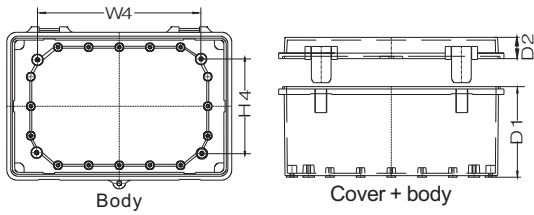

plastic latch+hinge type		Dimension(mm)		Mounting plate		installation size(mm)	
Grey door	Clear door	W X H X D	D1+D2	Plastic	Metal	W4	H4
TE-AG-1015	TE-AT-1015	100×150×70	50 + 20	TJ-1015P	TJ-1015	100	/
TE-AG-1020	TE-AT-1020	100×200×70	50 + 20	TJ-1020P	TJ-1020	150	/
TE-AG-1126-S	TE-AT-1126-S	110×260×75	55 + 20	/	TJ-1126	180	40
TE-AG-1126	TE-AT-1126	110×260×110	80 + 30	/	TJ-1126	180	40
TE-AG-1315	TE-AT-1315	135×155×80	60 + 20	/	TJ-1315	97.5	97.5
TE-AG-1318-S	TE-AT-1318-S	135×185×80	60 + 20	/	TJ-1318	131	100.7
TE-AG-1318	TE-AT-1318	135×185×110	90 + 20	/	TJ-1318	131	100.7
TE-AG-1515	TE-AT-1515	150×150×90	70 + 20	TJ-1515P	TJ-1515	100	100
TE-AG-1722	TE-AT-1722	170×220×110	80 + 30	TJ-1722P	TJ-1722	162	/
TE-AG-1727	TE-AT-1727	170×270×110	80 + 30	/	TJ-1727	100	120
TE-AG-1929	TE-AT-1929	190×290×140	110 + 30	TJ-1929P	TJ-1929	210	126
TE-AG-2530	TE-AT-2530	250×300×150	110 + 40	TJ-2530P	TJ-2530	282	230
TE-AG-2530-1	TE-AT-2530-1	250×300×180	140 + 40	TJ-2530P	TJ-2530	282	230
TE-AG-2535-1	TE-AT-2535-1	250×350×150	110 + 40	TJ-2535P	TJ-2535	275	175
TE-AG-2535	TE-AT-2535	250×350×180	140 + 40	TJ-2535P	TJ-2535	275	175
TE-AG-2919	TE-AT-2919	290×190×140	110 + 30	TJ-2919P	TJ-2919	126	210
TE-AG-2939	TE-AT-2939	290×390×160	132 + 28	TJ-2939P	TJ-2939	315	215
TE-AG-3030-S	TE-AT-3030-S	300×300×130	100 + 30	TJ-3030P	TJ-3030B	280	280
TE-AG-3030-A	TE-AT-3030-A	300×300×180	150 + 30	TJ-3030P	TJ-3030B	280	280
TE-AG-3546	TE-AT-3546	350×465×160	130 + 30	TJ-3546P	TJ-3546	410	295
TE-AG-3546-1	TE-AT-3546-1	350×465×200	170 + 30	TJ-3546P	TJ-3546	410	295



Steel mounting plate



Plastic mounting plate



Wall brackets for Plastic box
MOEDL:WP-02



Inner door hinge fixing
MOEDL:LC-S11



Fixing bolts for inner plate
MOEDL:LC-S12



close with lead sealing



closed with lock



Fixed with inner plate

TE series plastic enclosure-big size switch box(metal latch+hinge type)



metal latch+hinge type		Dimension(mm)		Mounting plate	
Grey door	Clear door	W X H X D	D1+D2	Metal	
TE-AG-5363-S	TE-AT-5363-S	530×630×185	150 + 35	TJ-5363	
TE-AG-5363	TE-AT-5363	530×630×255	220 + 35	TJ-5363	
TE-AG-5373-S	TE-AT-5373-S	530×730×185	150 + 35	TJ-5373	
TE-AG-5373	TE-AT-5373	530×730×255	220 + 35	TJ-5373	
TE-AG-6383-S	TE-AT-6383-S	630×830×185	150 + 35	TJ-6383	
TE-AG-6383	TE-AT-6383	630×830×285	220 + 35	TJ-6383	

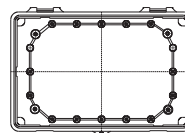

Body

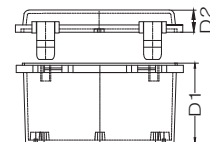

Cover + body



metal latch



hinge



wall brackets model:WP-02



Plastic enclosure

TB series plastic enclosure

Out of the plastic boxes which are selling at present, it's ability and working efficiency, the competitive power is much higher with the low price same as the level of steel box. The products were added the electromagnetic interference(EMI) and prevent substance of the static electricity, and the strong point was given to the relevant mechanical protection of electricity, electron and etc.

Temperature range:-40 to +120℃ ABS:Acrylonitrile Butadiene Styrene PC:Poly Carbonate

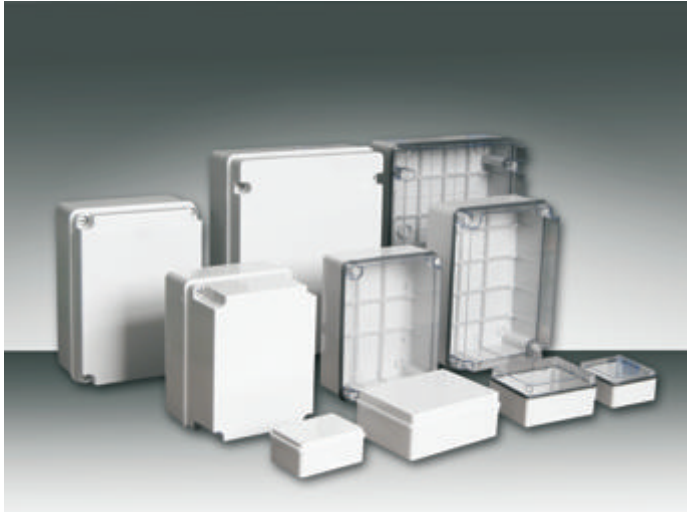

Plastic screw type		Dimension(mm)		Mounting plate	Installation size(mm)	
Grey door	Clear door	W X H X D	D1+D2		Metal	W3
TB-AG-0812	TB-AT-0812	80×120×50	40 + 14	TJ-0812	88	88
TB-AG-1010	TB-AT-1010	100×100×50	40 + 14	TJ-1010	68	108
TB-AG-1115	TB-AT-1115	110×150×70	49 + 25	TJ-1115	98	137
TB-AG-1419	TB-AT-1419	140×190×70	51 + 25	TJ-1419	128	177
TB-AG-1924	TB-AT-1924	190×240×90	70 + 25	TJ-1924	170	226
TB-AG-1924-1	TB-AT-1924-1	190×240×160	70 + 96	TJ-1924	170	226
TB-AG-2230	TB-AT-2230	220×300×120	76 + 50	TJ-2230	200	280
TB-AG-2230-1	TB-AT-2230-1	220×300×160	76 + 90	TJ-2230	200	280
TB-AG-3038	TB-AT-3038	300×380×120	78 + 50	TJ-3038	281	278
TB-AG-3038-1	TB-AT-3038-1	300×380×183	78 + 110	TJ-3038	281	278

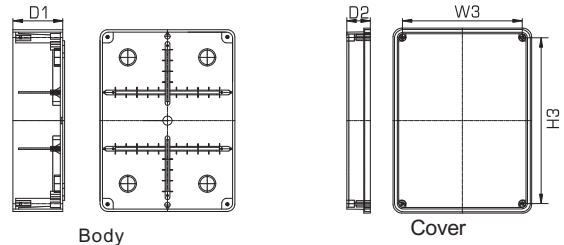

Metal mounting plate

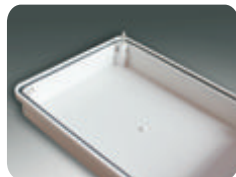

Size TBAG0812~TBAG1115 metal screw



Size TBAG1419~TBAG3038-1 plastic screw



Cover open at 90 degree



TB series plastic enclosure with rubber sealing



Plastic screw+knock out type		Dimension(mm)		Mounting plate	Installation size(mm)	
Grey door	Clear door	W X H X D	D1+D2		Metal	W3
TB-AG-C60R	TB-AT-C60R	φ60×45	/	/	/	/
TB-AG-C70R	TB-AT-C70R	φ70×48	/	/	/	/
TB-AG-0606R	TB-AT-0606R	75×75×45	41.7+ 10	/	/	/
TB-AG-0808R	TB-AT-0808R	89×89×50	46.5+ 10	/	/	/
TB-AG-0812R	TB-AT-0812R	80×120×50	40 + 14	TJ-0812	88	88
TB-AG-1010R	TB-AT-1010R	100×100×50	40 + 14	TJ-1010	68	108
TB-AG-1115R	TB-AT-1115R	110×150×70	49 + 25	TJ-1115	98	137
TB-AG-1419R	TB-AT-1419R	140×190×70	51 + 25	TJ-1419	128	177
TB-AG-1924R	TB-AT-1924R	190×240×90	70 + 25	TJ-1924	170	226
TB-AG-1924-1R	TB-AT-1924-1R	190×240×160	70 + 96	TJ-1924	170	226
TB-AG-2230R	TB-AT-2230R	220×300×120	76 + 50	TJ-2230	200	280
TB-AG-2230-1R	TB-AT-2230-1R	220×300×160	76 + 96	TJ-2230	200	280
TB-AG-3038R	TB-AT-3038R	300×380×120	76 + 50	TJ-3038	281	278
TB-AG-3038-1R	TB-AT-3038-1R	300×380×180	70 + 110	TJ-3038	281	278

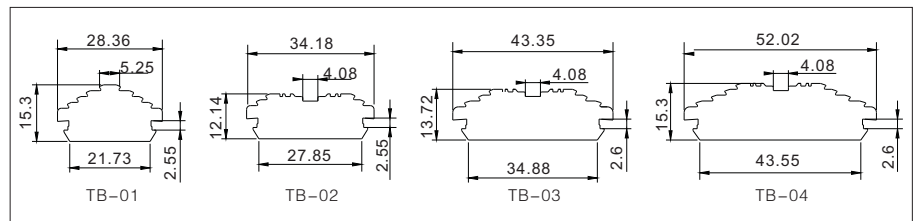

Terminal block box

Terminal block box

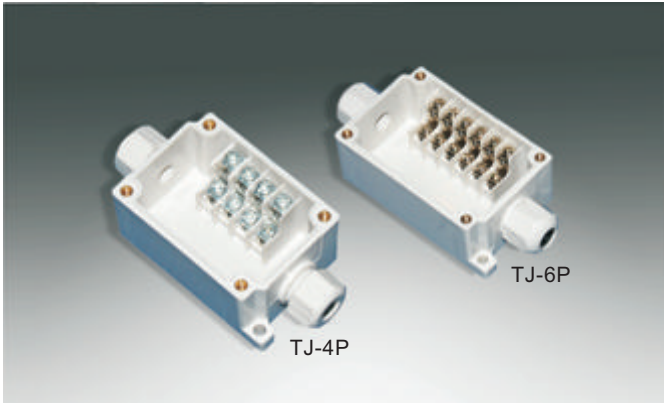

TJ-4P, TJ-6P

Screw type	Dimension(mm)		installation size(mm)	
	W X H X D	D1+D2	W3	H3
TJ-4P	102×50×40	33 + 8	72.5	41
TJ-6P	125×55×40	33 + 8	88	46

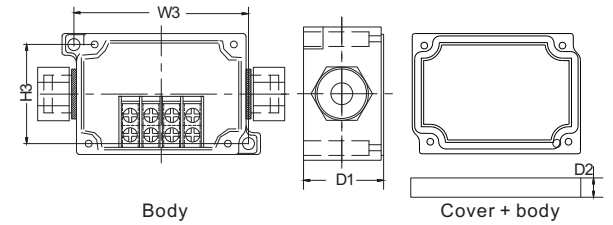

TJ-4P-K, TJ-6P-K

Screw type	Dimension(mm)		installation size(mm)	
	W X H X D	D1+D2	W3	H3
TJ-4P-K	70×55×43	35 + 8	57.8	41
TJ-6P-K	91×55×43	35 + 8	81	45

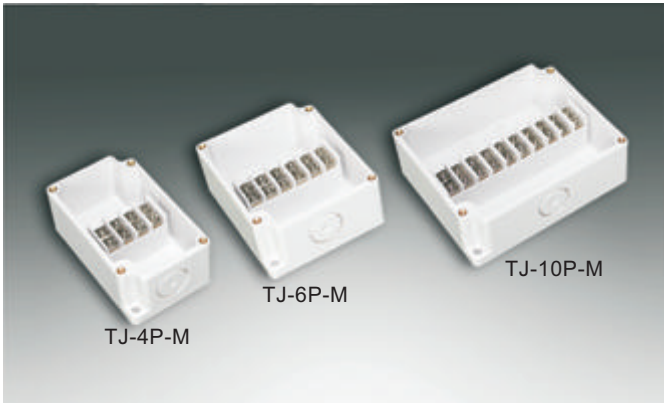
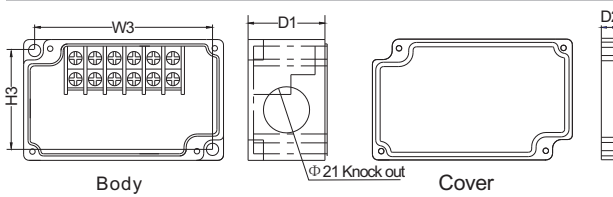

TJ-4P-M, TJ-6P-M, TJ-10P-M

Screw type	Dimension(mm)		installation size(mm)	
	W X H X D	D1+D2	W3	H3
TJ-4P-M	91×55×43	33 + 8	78	47
TJ-6P-M	91×75×43	33 + 8	81	65
TJ-10P-M	110×91×43	36 + 8	102	84

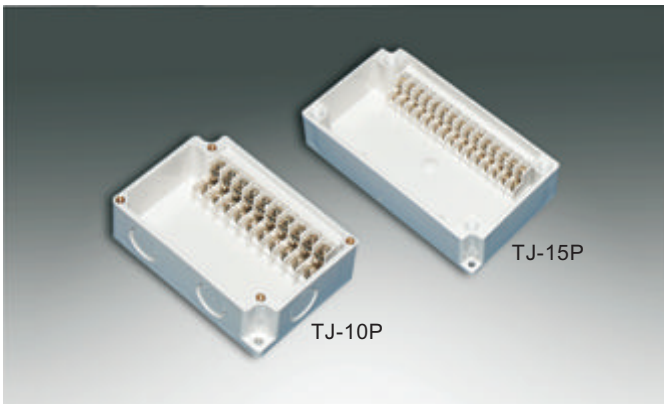
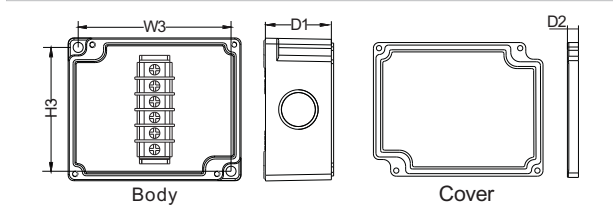

TJ-10P, TJ-15P

Screw type	Dimension(mm)		installation size(mm)	
	W X H X D	D1+D2	W3	H3
TJ-10P	110×75×40	32 + 8	100	65
TJ-15P	180×110×55	39.5 + 16	168	88

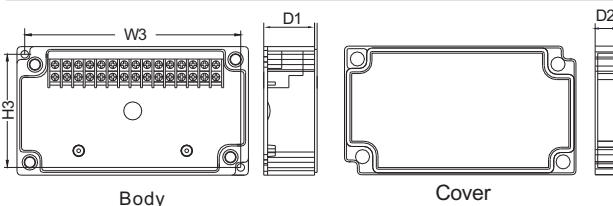

Terminal block box

Terminal block box

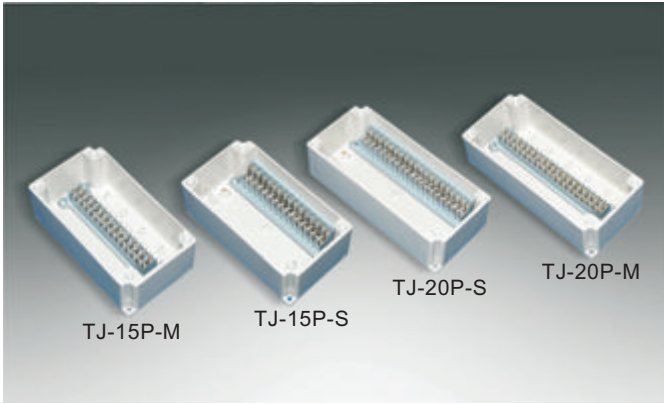

TJ-15P-S, TJ-20P-S, TJ-15P-M, TJ-20P-M,

Screw type	Dimension(mm)		installation size(mm)	
	W X H X D	D1+D2	W3	H3
Grey door				
TJ-15P-S	180×100×75	60 + 16	168	88
TJ-20P-S	223×100×75	60 + 16	213	92
TJ-15P-M	180×100×75	60 + 16	168	88
TJ-20P-M	223×100×75	60 + 16	213	92

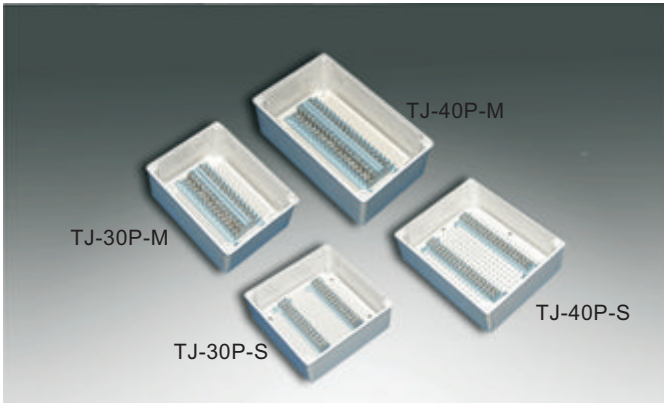
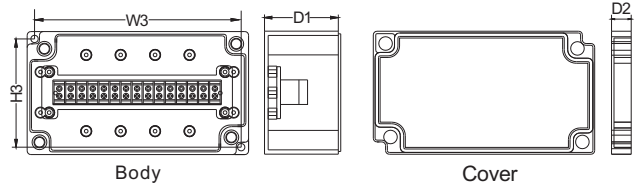

TJ-30P-S, TJ-30P-M, TJ-40P-S, TJ-40P-M

Screw type	Dimension(mm)		installation size(mm)	
	W X H X D	D1+D2	W3	H3
Grey door				
TJ-30P-S	200×150×100	80 + 20	181	131
TJ-30P-M	200×200×95	75 + 20	181	181
TJ-40P-S	250×150×100	80 + 20	232	131
TJ-40P-M	250×200×100	75 + 25	232	182

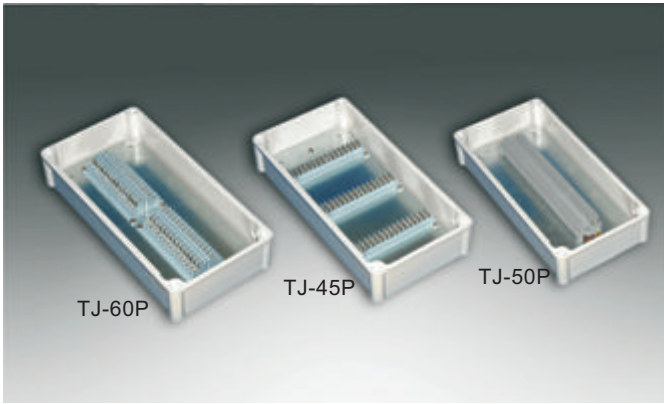
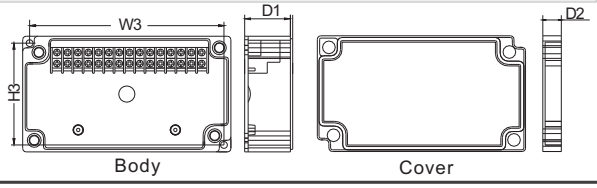

TJ-45P, TJ-50P, TJ-60P

Screw type	Dimension(mm)		installation size(mm)	
	W X H X D	D1+D2	W3	H3
Grey door				
TJ-45P	380×190×100	70 + 30	356	166
TJ-50P	380×190×100	70 + 30	356	166
TJ-60P	380×190×100	70 + 30	356	166

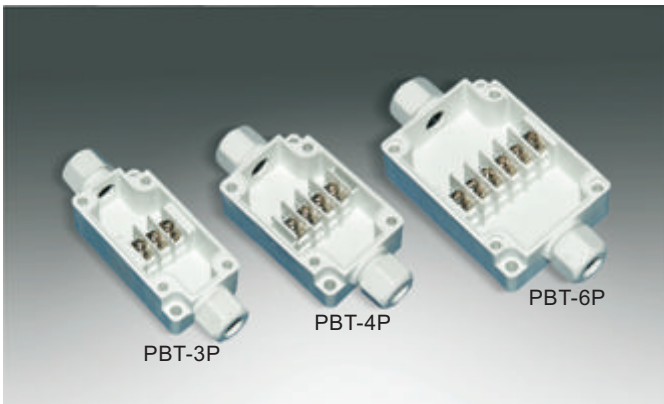
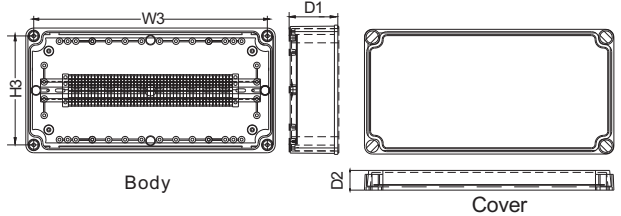

PBT-3P, PBT-4P, PBT-6P

Screw type	Dimension(mm)		installation size(mm)	
	W X H X D	D1+D2	W3	H3
Grey door				
PBT-3P	65×33×24	19.5 + 4.5	57.8	25.8
PBT-4P	60×40×24	19.5 + 4.5	52.8	32.8
PBT-6P	70×50×24	19 + 5	62	42

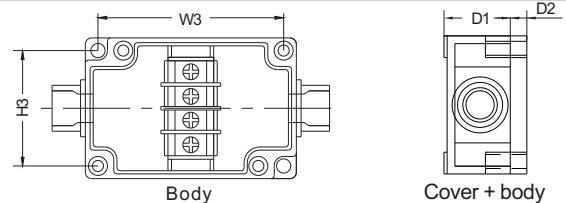

TJ series industrial socket plastic box

TJ series plastic enclosure

High strength PC refractory and UV add material, appearance is beautiful and easy, has the very high plasticity and robustness. Applicable to the outlet box, terminal box, Distribution board, instrument BOX, BOX and control BOX convenient for power equipment. Dismountable and design unique hinge, up and down or so can be opened.



Screw type	Screw type	Dimension(mm)	Mounting plate	Thickness of box		Depth of box		Hinge model	Plate size	
				Cover	Body	Cover	Body		M1	M2
Grey door	Clear door	W X H X D	Metal							
TJ-AG-2234	TJ-PG-2234	220X340X145	TJ-2234	5mm	5mm	40mm	105mm	HG-05	195	315
TJ-AG-2730	TJ-PG-2730	270X300X145	TJ-2730	5mm	5mm	40mm	105mm	HG-05	245	275
TJ-AG-3040	TJ-PG-3040	300X400X160	TJ-3040	5mm	5mm	55mm	105mm	HG-06	273	373
TJ-AG-2746	TJ-PG-2746	270X460X160	TJ-2746	5mm	6.5mm	55mm	105mm	HG-06	243	433
TJ-AG-3052	TJ-PG-3052	300X520X160	TJ-3052	5mm	6.5mm	55mm	105mm	HG-06	273	493
TJ-AG-3654	TJ-PG-3654	360X540X180	TJ-3654	5mm	6.5mm	55mm	105mm	HG-07	326	506

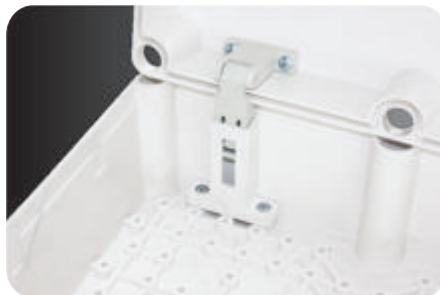

TJ series industrial socket plastic box



Model:TJ-AG-2234 Size:220x340x145mm

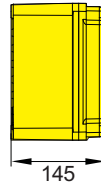
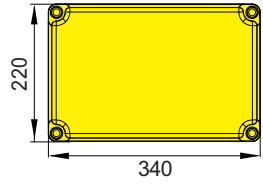

Error:± 1mm



Model:TJ-AG-2730 Size:270x300x145mm

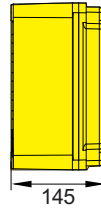
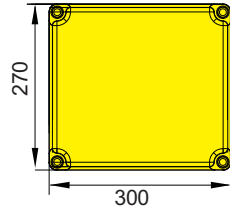

Error:± 1mm



Model:TJ-AG-3040 Size:300x400x160mm

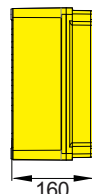
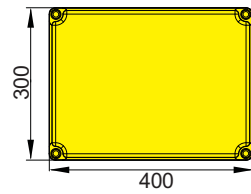

Error:± 1mm



Model:TJ-AG-2746 Size:270x460x160mm

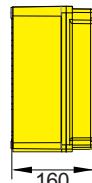
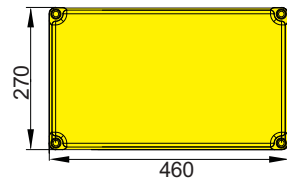

Error:± 1mm



Model:TJ-AG-3052 Size:300x520x160mm

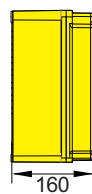
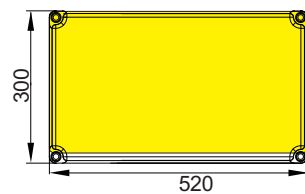

Error:± 1mm



Model:TJ-AG-3654 Size:360x540x180mm

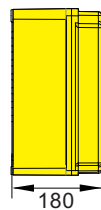
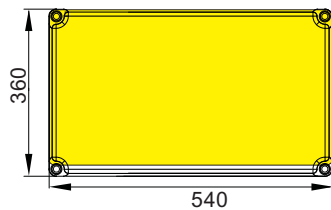

Error:± 1mm



TJ series Non-standard plastic enclosure

TJ series Non-standard plastic enclosure



Model:TJ-T01 Size:124x110x82mm

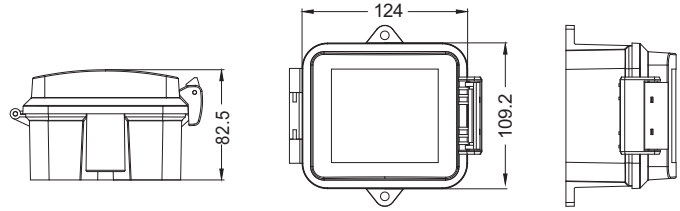

Error:±1mm

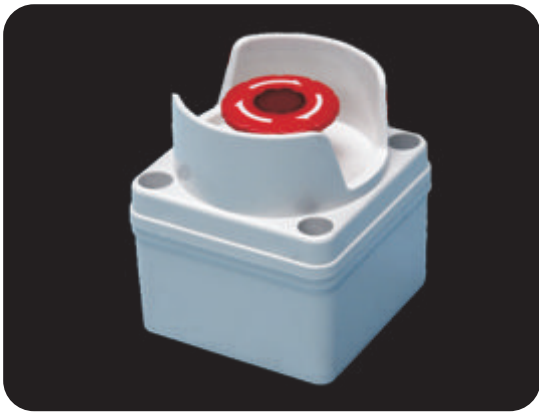

Model:TJ-T02 Size:80x80x180mm

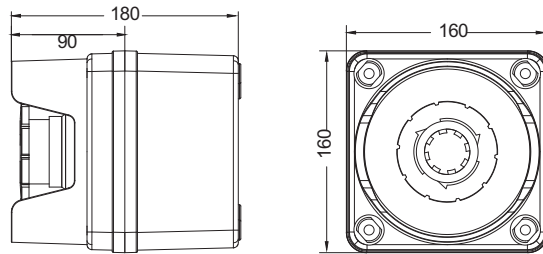

Error:±1mm



Model:TJ-T03 Size:160x82x118mm

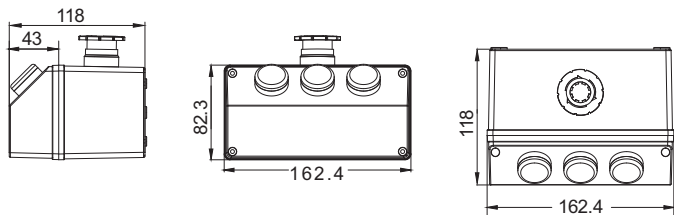

Error:±1mm



■ Non-standard custom development services

According to customer needs, providing a variety of programs, the development of non- standard client

